

- MONOFILAMENT
- HEADS
- SPECIAL APPLICATIONS
- BLADES
- PPE
- SPARE PARTS AND ADAPTERS



*Top rated professional experience.*  
Components made in Italy since 1997.





***Top rated professional experience.***  
Components made in Italy since 1997.

# INDEX

<b>Our story</b>	<b>05</b>
<b>Monofilament</b>	<b>07</b>
Our Monofilament range	09
For brush cutter	10
Packaging	18
Our services	20
Technical	24
<b>Heads</b>	<b>33</b>
Tap&go	34
Multi-wire	38
<b>Special applications</b>	<b>49</b>
Rotary tiller	50
Suckers remover	56
Brushes and accessories	62
<b>Blades</b>	<b>69</b>
Steel blades	72
<b>PPE</b>	<b>77</b>
Face shields	78
Brushcutter guard	80
Shoulder straps	81
<b>Spare parts and adapters</b>	<b>83</b>



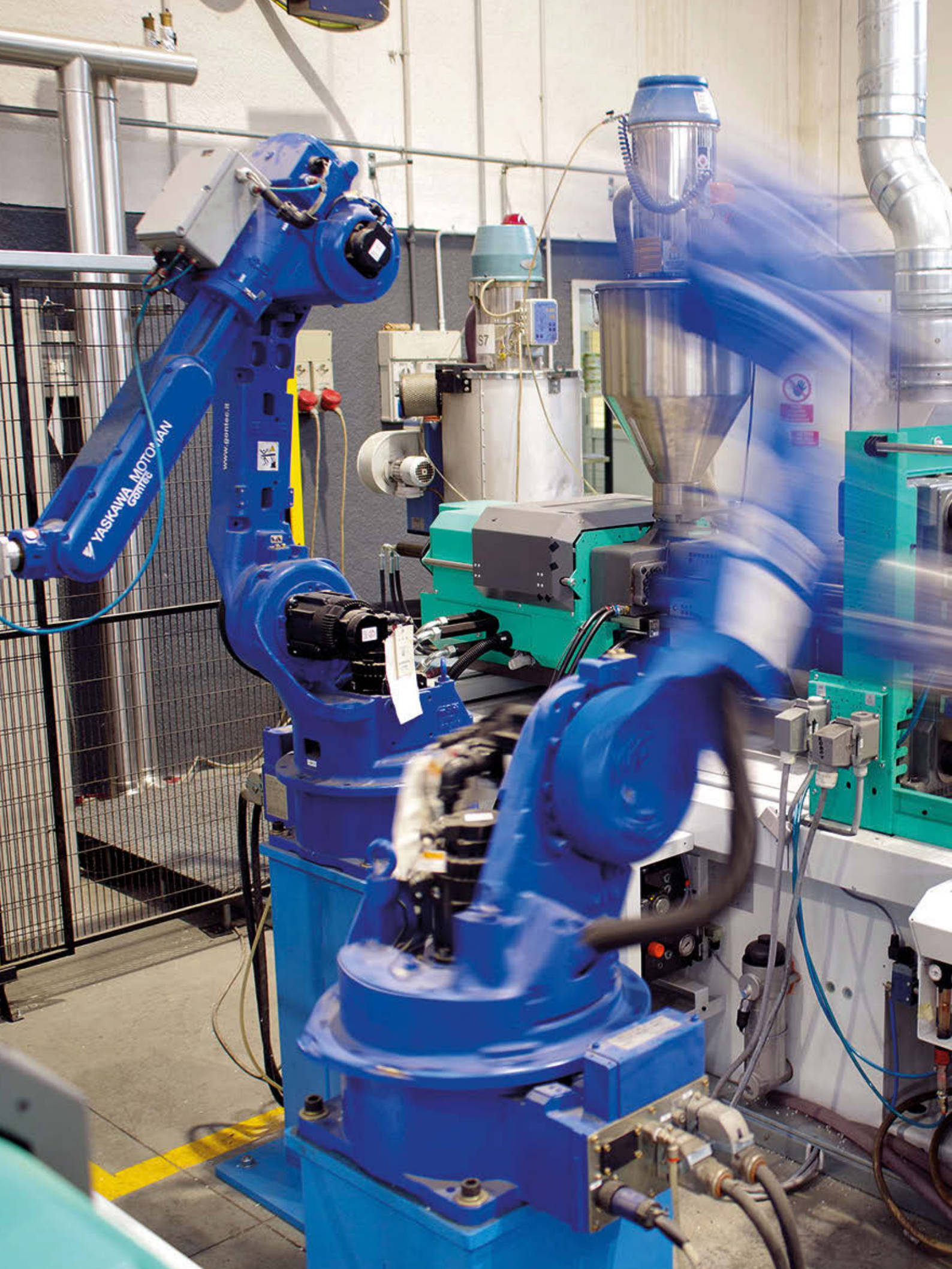

# OUR STORY



Twenty-five years of experience in the garden equipment and in the molding of plastic components, with quality certifications that are constantly renewed.

AGP is currently one of the very few companies on the market to offer a complete catalogue of monofilaments and gardening products completely designed and manufactured in-house.

Even with an export between 40 and 50% of its production, AGP chooses to not delocalise and to remain “zero miles” in terms of suppliers too, maintaining high quality standards and speed of response to the customers’ needs.



Worldwide first in the gardening market to produce monofilaments made of recycled plastic using polyamides from chemical recycling, thus reducing the use of raw materials of fossil origin.

“Pyroline” is our range of filaments from circular economy, presented at EIMA 2021 and followed in 2022 by “Pyroline Whisper” which enhances the concept reducing noise emissions and fuel consumption because of the wire.

In 2020, widening the view on the sector, AGP also invested in the production of face shields.

Today we make in-house six different models complying to the last CE regulations.



In August 2018, the company moved to the new factory headquarter, spread over 4,800 square meters of covered area and 22,000 square meters of open areas.

The new plant is equipped with a 280Kw photovoltaic system and charging stations for electric cars.

In 2017 the quality system certification is updated to ISO 9001:2015, to confirm its production standards.



Willing to approach and develop new markets, AGP has, in 2015, included a new manufacturing line for the production of monofilaments FFF (Fused Filament Fabrication) for 3D printers.

In 2012 AGP obtained the certification of quality assurance system in accordance with Standard ISO 9001: 2008.

In 2007 “Attila Garden Product sas” becomes AGP srl. The newco starts its own production of monofilaments for different applications: garden power tools, agriculture and industry (fencewire, tannery, electrical).



In the year 2000 AGP decided to invest in machineries and infrastructure needed to produce and assemble its own heads. “Attilina” hits the market, allowing the company to achieve high sales volumes in Italy and becoming a player in the international gardening market.

AGP participated at worldwide trade fairs like GAFA in Cologne, Germany and EIMA in Bologna, Italy which will continue in the following years.

In 1997 “Attila Garden Product sas” was founded to industrialize the production of a trimmer head previously made in a traditional way.

The first step was to design and engineer the moulds for the brushcutter head “Attila”, a universal/multifilament model featuring extraordinary strength and ease of use.



**Top rated professional experience.**

Components made in Italy since 1997.





***Top rated professional experience.***  
Components made in Italy since 1997.

# MONOFILAMENT

<b>Our Monofilament range</b>	<b>09</b>
<b>For brush cutter</b>	
Nylgrass	10
Alu Made	11
Magic Line	12
Stratus	13
Vertigo ( <i>Low noise</i> )	14
Whisper ( <i>Low noise</i> )	15
Stratus Huracan ( <i>Low noise</i> )	16
Pyro Line ( <i>Circular Economy</i> )	17
Packaging	18
Our services	20
<b>Technical</b>	
Elasto Fil	24
NyoFuel	26
Nyofil	28
Nyofil industrial	29
Feelcolor	31

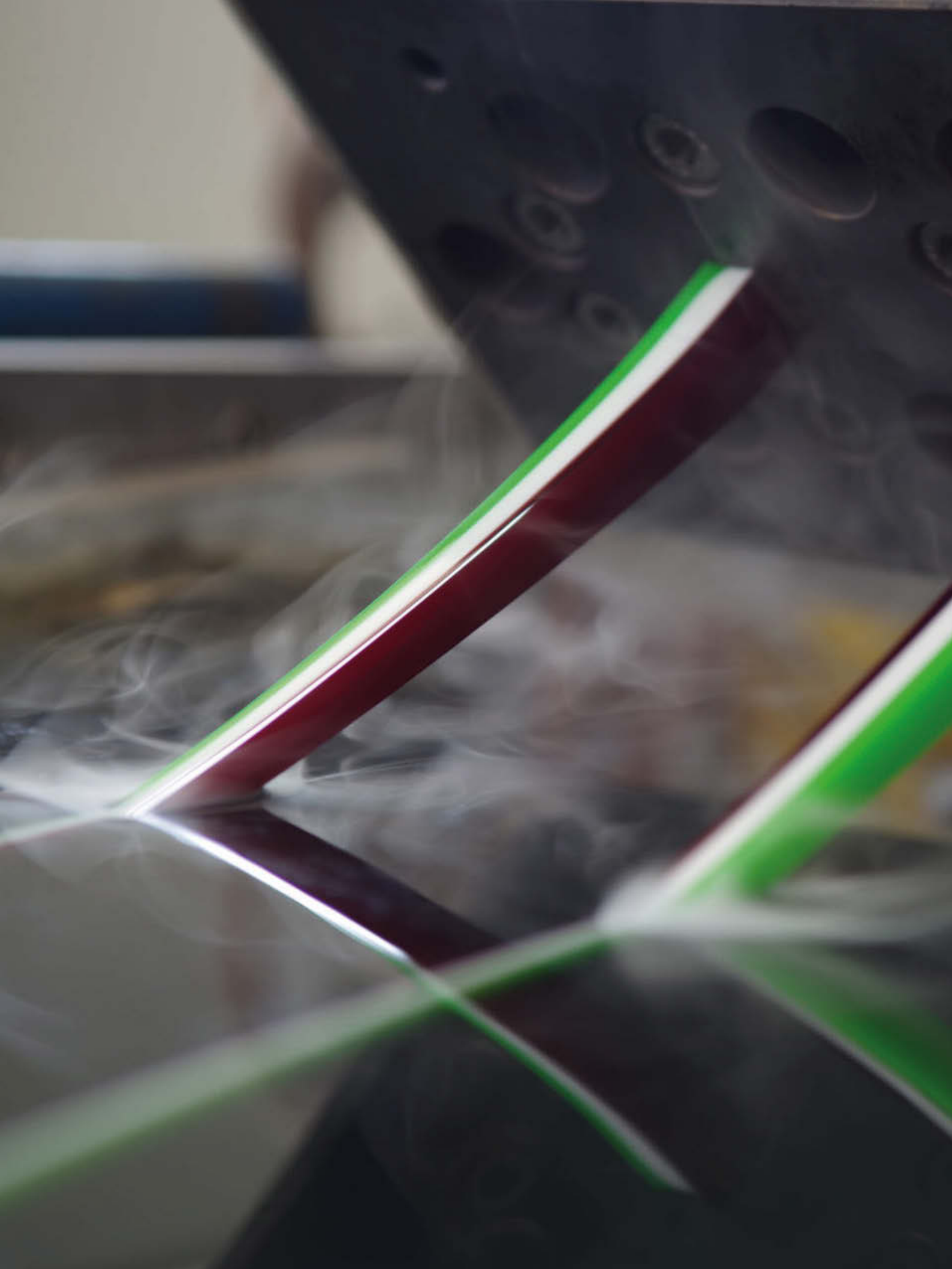



## Trimmer Line

**Nylgrass** is a professional quality trimmer line monofilament, made of the best co-polymer available on worldwide market. We do not supply different quality grades, just “the best” to face an hard work like grass cutting, where top flexibility and top strenght are the minimum features required. We mean “no compromise” on quality: the best raw materials, the most advanced extrusion system, full range of shapes, colours and packaging available. Considering our market experience and flexibility on service, we are the right partner to develop your trimmer line business.



## Tecnical Wire

**Nyofil** is a PA 6 monofilament extruded with high technology system for agriculture and industry application. Tough and flexible, it can easily replace steel wire.



## 3D printer filament

Under **Feelcolor** brand, AGP manufactures and distributes top quality 3D filaments available in huge range of materials, colors and packagings.

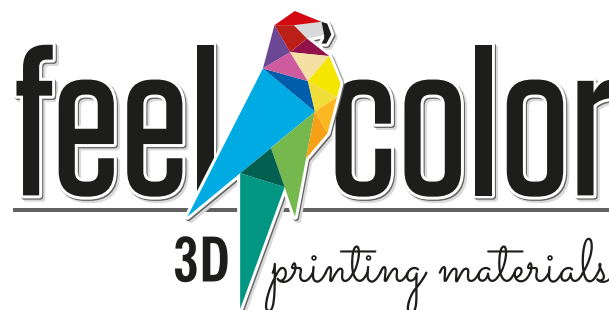

For brush cutter

# Nylgrass









## Professional trimmer line

Nylgrass is a professional quality trimmer line monofilament, made of the best co-polymer available on worldwide market. We do not supply different quality grades, just "the best" to face an hard work like grass cutting, where top flexibility and top strength are the minimum features required.

Made in Italy



### Available profiles

 square 1.3 > 5.0	 round 1.3 > 6.0
 penta 1.3 > 5.0	 hexa 1.3 > 5.0
 star 1.6 > 5.0	 tria 1.3 > 5.0
 corner 1.3 > 5.0	 ellipse 3.0 > 7.0



For brush cutter

# Alu Made

## Trimmer line with aluminum

POLYMER + METAL = ALUMAIDE®





A special formula HD (heavy duty polymers) that combines the basic features of Nylgrass and the high resilience of the metal component.

For those who need the best performance in the most extreme cutting conditions.

Made in Italy



### Available profiles

 square 1.3 > 5.0	 round 1.3 > 6.0
 penta 1.3 > 5.0	 star 1.6 > 5.0
 ellipse 3.0 > 7.0	





For brush cutter

# Magic Line

## Co-extruded Trimmer line

The state of the art of our trimmer lines.  
An outer shell more resistant to breakage and wear, an inner core copolymer HD super flexible.  
The quality made monofilament available in round and square section.

Made in Italy

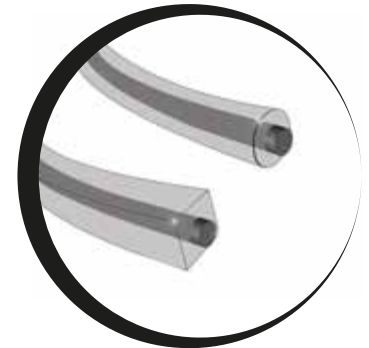
### MAGIC LINE

Available profiles



square  
2.0 > 4.5



round  
2.0 > 4.5



For brush cutter

# Stratus

## Tri-extruded professional wire

Monofilament for brush cutter.

This filament is made of high quality polymers, with cutting-edge production technologies and according to a proprietary recipe developed by AGP.

Available with various colors.

Made in Italy



### STRATUS

Available profiles



square  
2.0 > 4.5



round  
2.0 > 4.5



For brush cutter

# Vertigo

## Low noise and aerodynamic wires

An aerodynamic profile means low noise, but above all, low air resistance and therefore less fuel waste and maximum yield for the machine.

Best cutting performances when used on our range of multi filament heads.

Available with various colors in elliptical section.

Made in Italy



### Available profiles



vertigo  
3.0 > 4.5



LESS NOISE



LESS FUEL CONSUMPTION



LESS WIRE BREAKAGES



MORE WIRE DURATION





For brush cutter

# Whisper

## Squared low noise and aerodynamic wires

An aerodynamic profile reduces noise and air resistance meaning less fuel waste and maximum yield for the machine.





Best cutting performances when used on our range of multi filament heads.

Available with various colors in square sections, single extrusion and co-extruded.

Made in Italy



### Available profiles

 <p><b>square</b> 3.0 &gt; 4.5</p>	 <p><b>co-extruded</b> 2.0 &gt; 4.5</p>
 <p><b>tri-extruded</b> 2.0 &gt; 4.5</p>	 <p><b>pyro line</b> 2.0 &gt; 4.5</p>



LESS NOISE



LESS FUEL CONSUMPTION



LESS WIRE BREAKAGES



MORE WIRE DURATION

For brush cutter

# Stratus Huracan

## Top performance wire

Huracan is the top of our monofilament range: triple extrusion combined with low noise profile.

Maximum cutting performance from weed to brambles. Resistance to abrasion, stretching and breakage: longer life means less wire needed.

Low noise and less fuel consumption for the maximum yield of the machine.

Available in various colour combinations.

Made in Italy



### Available profiles



huracan  
3.0 > 4.5



LESS NOISE



LESS FUEL CONSUMPTION



LESS WIRE BREAKAGES



MORE WIRE DURATION

For brush cutter

# Pyro Line





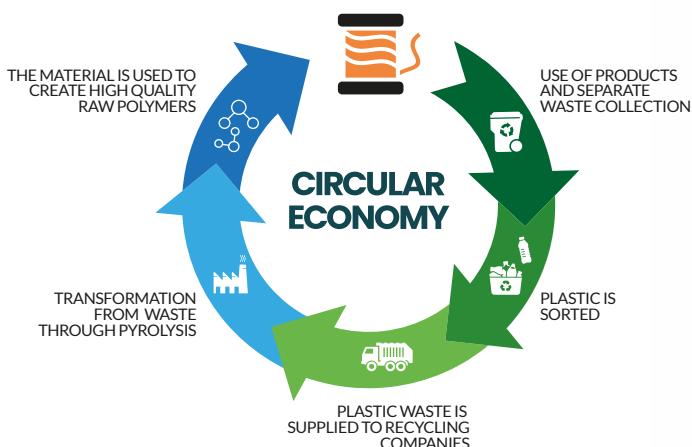

## Professional line from circular economy

Monofilament 100% PA from circular economy. The original products are transformed, using the pyrolysis process, into raw material (pyrolysis oil) later used to produce polymers identical to those of petroleum derivatives as certified by Ecocycle GmbH according to ISO 14021:2016. Monofilament with high end performance, a net reduction of carbon emissions and the total absence of raw materials of fossil origin.

Made in Italy



### Available profiles

 <b>square</b> 1.3 > 5.0	 <b>round</b> 1.3 > 6.0
 <b>penta</b> 1.3 > 5.0	 <b>hexa</b> 1.3 > 5.0
 <b>star</b> 1.6 > 5.0	 <b>tria</b> 1.3 > 5.0



For brush cutter

# Packaging



Category

Precutted wire

Package

cable ties

Box pcs.

100

Pallet pcs.

2400



Category

Precutted wire

Package

tube

Box pcs.

75

Pallet pcs.

1800



Category

15 meters

Package

spool with cable  
ties (in bag)

Box pcs.

 $\varnothing \leq 2.7\text{mm}$  100  
 $\varnothing \geq 3.0\text{mm}$  70

Pallet pcs.

2400  
1680

Category

15 meters

Package

spool with cable  
ties

Box pcs.

100

Pallet pcs.

2400



Category

15 meters

Package

blister (no feet)

Box pcs.

100

Pallet pcs.

2400



Category

15 meters

Package

blister (with feet)

Box pcs.

40

Pallet pcs.

1600



Category

1 pound

Package

spool with cable  
ties (in bag)

Box pcs.

25

Pallet pcs.

600



Category

1 pound

Package

donut (no feet)

Box pcs.

24

Pallet pcs.

576



Category

1 pound

Package

donut (with feet)

Box pcs.

24

Pallet pcs.

576



Category

1LB spool

Package

spool light

Box pcs.

36

Pallet pcs.

1080

*For brush cutter*

Category

DIN 125 spool

Package

spool heavy

Box pcs.

18

Pallet pcs.

540



Category

3LB spool

Package

spool light

Box pcs.

18

Pallet pcs.

504



Category

DIN 160 spool

Package

spool heavy

Box pcs.

6

Pallet pcs.

240



Category

4LB spool

Package

spool light

Box pcs.

9

Pallet pcs.

252



Category

DIN 200 spool

Package

spool heavy

Box pcs.

6

Pallet pcs.

168



Category

5LB spool

Package

spool light

Box pcs.

6

Pallet pcs.

168



Category

DIN 350 spool

Package

spool heavy

Box pcs.

1

Pallet pcs.

72

## Customizations

### Private label and custom packaging for a turnkey outsourcing service

AGP offers a wide range of packaging and tailor-made solutions carried out in-house to ensure maximum flexibility and short delivery time.

Labels are designed in collaboration with the customer's needs, following the company corporate design or creating your brand.

Monofilaments are available in various shapes, sizes and colours, including fluorescent, metallic (alu) and multi-colored (bi-extruded and tri-extruded).

Even more we can laser mark your logo on our big choice of steel blades







**YOUR  
PRIVATE  
LABEL**

  
MADE IN ITALY













# Elasto Fil

## Wire for agricultural sucker remover

Wire for agricultural sucker remover, made with thermo-plastic elastomer co-extruded with textile core.

High performance line with top resiliency.

Flexible to reduce the damage on plants but strong enough to clean the base.

Diameters: 5/6/7/8 mm.

Made in Italy

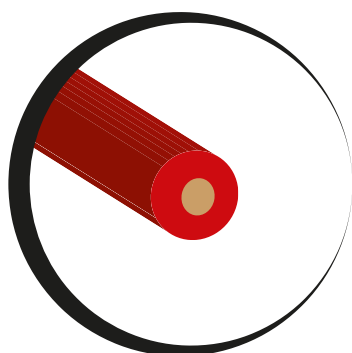

ATSPCPO50TQK  
Ø 5 mm

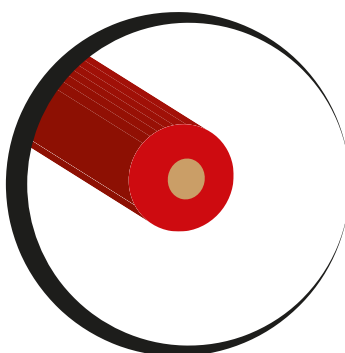

ATSPCPO60TQK  
Ø 6 mm

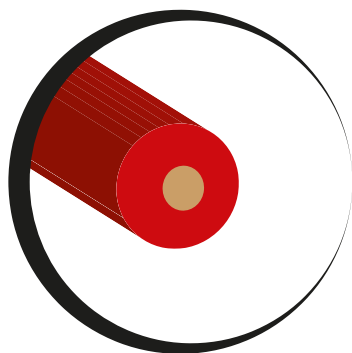

ATSPCPO70TQK  
Ø 7 mm

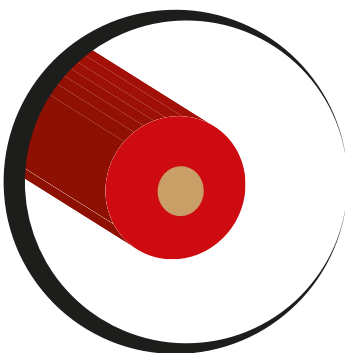

ATSPCPO80TQK  
Ø 8 mm







## NyoFuel

### TPU fuel hoses

Professional TPU fuel hoses.  
High flexibility and wear resistance.  
TPU guarantees maximum durability and resistance to hydrocarbons.  
Available in various diameters, suitable for 2 and 4 stroke engines.

Code	Description
ATTB2448-15	NyoFuel TPU Ø 2.4 x 4.8 mm - 15 m
ATTB3250-15	NyoFuel TPU Ø 3.2 x 5.0 mm - 15 m
ATTB4880-05	NyoFuel TPU Ø 4.8 x 8.0 mm - 5 m
ATTB6298-05	NyoFuel TPU Ø 6.2 x 9.8 mm - 5 m



High performance tubes for fuel and lubricants

High wear resistant  
Compatible with most of hydrocarbons  
Resistant to swelling  
High flexible and ease of use  
Specifically developed for fuels & lubricants

Made in Italy

ATTB6298-05  
ATTBPVC62-05  
0.244 x 0.385 in

ATTB4880-05  
ATTBPVC48-05  
0.188 x 0.314 in

ATTB3250-15  
ATTBPVC32-15  
0.125 x 0.196 in

ATTB2448-15  
ATTBPVC24-15  
0.094 x 0.188 in

## High Torque

### PVC fuel hoses

PVC fuel hoses.  
Long life and resistance to hydrocarbons.  
Available in various diameters, suitable for 2 and 4 stroke brushcutters.

Code	Description
ATTBPVC24-15	PVC HIGH-TORQUE Ø 2.4 x 4.8 mm - 15 m
ATTBPVC32-15	PVC HIGH-TORQUE Ø 3.2 x 5.0 mm - 15 m
ATTBPVC48-05	PVC HIGH-TORQUE Ø 4.8 x 8.0 mm - 5 m
ATTBPVC62-05	PVC HIGH-TORQUE Ø 6.2 x 9.8 mm - 5 m





# Nyofil

## Agricultural and multipurpose wire

Nyofil is a PA6 monofilament produced with the most advanced extrusion technologies  
Wide range of uses from domestic to agriculture.  
Made with high quality polymers, Nyofil is strong and elastic and can be used instead of metal wires.  
It doesn't oxidize and is not corrosive.

Main features:

- High tensile mechanical strength.
- Flexible and elastic.
- High resistance to atmospheric agents.
- Non-abrasive.
- Chemical inertness that guarantees long life.
- Up to 7 times lighter than steel wires.

Steel tensioners and aluminum wire clamps are also available.

Made in Italy



### Applications

As a soft support of growing plants.  
For vineyards trellis.  
For grazing and electric fencing  
As a support for sheets, tarpaulins and nets

ATMR001  
ATMR002



Aluminum clamps - Steel tensioner		
Code	Description	
ATMR001	clamp for Ø 3.0 mm wire	conf. 2000 pz
ATMR002	clamp for Ø 4.0 mm wire	conf. 2000 pz
ATMR003	tensioner	conf. 1000 pz



ATMR003  
Min. 100 mm  
Max 140 mm

Code	Ø mm	Package		
		Yeld m/Kg	Breaking	L. Box*
AS0014	1.4	568	55	6818 m
AS0016	1.6	474	75	5687 m
AS0018	1.8	364	95	4364 m
AS0020	2.0	283	120	3400 m
AS0023	2.3	231	150	2778 m
AS0025	2.5	183	190	2200 m
AS0028	2.8	152	230	1818 m
AS0030	3.0	127	280	1519 m
AS0034	3.4	100	350	1188 m
AS0040	4.0	72	480	870 m
AS0044	4.4	59	580	700 m
AS0050	5.0	47	720	560 m

(\* ~12Kg - 53x55x14) More diameters available on request



# Nyofil Industrial

## Wire for electrical and industrial applications

Nyofil is a PA6 monofilament produced with the most advanced extrusion technologies. Wide range of uses in industrial and professional fields. Made with high quality polymers, Nyofil is strong and elastic. It doesn't oxidize and is not corrosive. High tensile mechanical strength both in traction and push.

Main features:

- Stiffness and elastic return.
- Flexible and elastic.
- High resistance to atmospheric agents.
- Non-abrasive, smooth and easy to slide.
- Chemical inertness that guarantees long life.

Made in Italy



### Applications

In tannery industry for leather colouring process. As guide for electrical probes thanks to its mechanical strength and flexibility.

Code	Description	Package	Yeld m/Kg
AS0170201	NYOFIL 2 mm	sprocket DIN 250	1360 m (4,8 Kg)
AS0170201-35	NYOFIL 2 mm	sprocket DIN 250	992 m (3,5 Kg)
AS0030M	NYOFIL 3 mm neutral color	spool	1456 m
AS0020	NYOFIL 3 mm black color	spool	1456 m
AS0023	NYOFIL 3 mm neutral color	spool	833 m
AS0025	NYOFIL 3 mm black color	spool	833 m



# feel color

3D printing materials

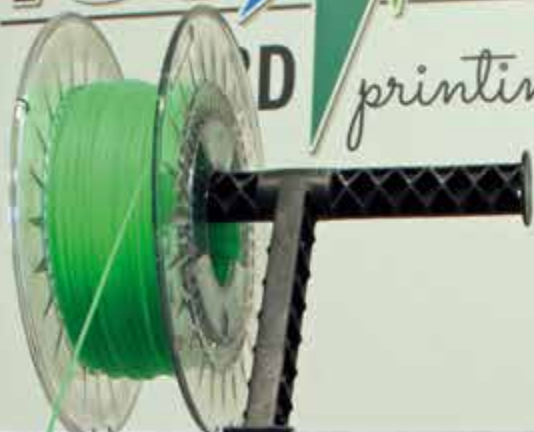

# Feelcolor

## 3D printer filament

PLA, ABS, KANOVA, HIPS, PETG, TPU, PETG CARBON.  
This is the range of raw materials we use to extrude 3D monofilaments.  
Our research and development dept is at work everyday to find materials with new capabilities and features.  
That's why our range of products is constantly evolving to meet the future needs of our customers.

QUALITY 100% MADE IN ITALY  
3d printer wire with diameter 1.75 or 2.85 mm.  
Every meter of wire that comes out of our production department is subjected to automatic and human controls to ensure that diameters and colors meet the highest quality standards.

[www.feel-color.com](http://www.feel-color.com)



### Packaging

300 gr  
1 Kg  
1.5 Kg  
2.5 Kg







***Top rated professional experience.***  
Components made in Italy since 1997.



# HEADS

*Heads for brushcutter 100% made in Italy, produced with aluminum or polyamide.*

*For all kind of use, from hobby to Pro, with different charging systems, based on a quick and easy recharge of trimmer line. Available heads with high wire capacity and "tap'n'go" heads.*

*Made of polymers with high mechanical resistance, using the most innovative industrial solutions.*

## **Tap&Go**

Garden Devil	34
Smart 2.0	35

## **Multi-wire**

Emily	36
Attilina	38
Queen	38
Prince	39
Mini Mulcher	40
Attila	41
Trottola Maxi	42
Vittoria	43
Sgorbio	43
Tango	44
Baffo	45
Dominator 3 - 6	46
Ninja	47

TAP&amp;GO

# Garden Devil

## Universal head Tap&Go

Universal or specific attachment version.

Also available with steel reinforced sprocket or with steel idler cup on ball bearings.

High capacity of wire, (7m round 3.0mm) maximum ease and speed of charging.

Tornado System prevents the grass winding on the gear box.

Made of high resistance polymers.

125 mm diameter.

Made in Italy

Mount	Standard	Metal Plate	Spinning
<b>UNIVERSAL</b>	<b>ATBVA10</b>	<b>ATBVA50</b>	<b>ATBVA110</b>
8x1.25 F	ATBVA11	ATBVA51	ATBVA111
8x1.25 M	ATBVA12	ATBVA52	ATBVA112
8x1.25 M EFCO	ATBVA13	ATBVA53	ATBVA113
10x1 F STIHL	ATBVA14	ATBVA54	ATBVA114
10x1 F	ATBVA15	ATBVA55	ATBVA115
10x1.25 F	ATBVA16	ATBVA56	ATBVA116
10x1.25 M	ATBVA17	ATBVA57	ATBVA117
10x1.5 F	ATBVA18	ATBVA58	ATBVA118
10x1.5 M	ATBVA19	ATBVA59	ATBVA119
12x1.5 F	ATBVA20	ATBVA60	ATBVA110

Sx / Left Handed threaded pins  
M=male / F=female

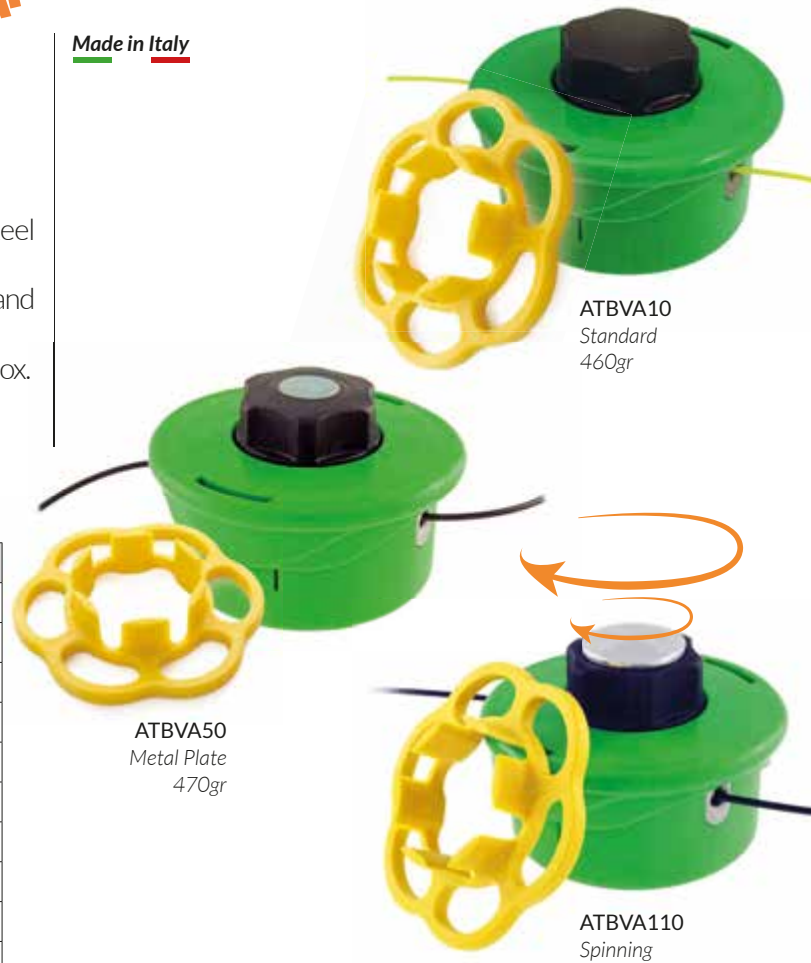

**MAGIC KEY:**  
easy charge tool included.

FIND OUT MORE



ATBVA03

Aluminum eyelet sleeves replacement



ATBVA05-NE

Standard sprocket replacement



ATBVA06-NE

Reinforced sprocket replacement



ATBVA26

Steel idler cup sprocket replacement



ATBVA04

Spring replacement

Box Pcs 24

Pallet Pcs 576

TAP&amp;GO

Made in Italy

# Smart 2.0

## Universal head Tap&Go

Universal head for brushcutter.  
High wire capacity, (9m round 3.0mm) fast load without disassembly.  
Made of high-strength polymers.  
Also available with metal plate.  
135 mm diameter.

Available models	
Mount	Code
UNIVERSAL	ATBS001
METAL PLATE F.25.4	ATBS100
METAL PLATE F.20	ATBS100-20





# Emily

## Semiautomatic head with bolts

Manual head with bolts.  
Made of special plastic material.  
Available in all types of attacks.

Made in  Italy

Available models	
Mount	Code
6x1 DxM	ATEM003
6x1 SxM	ATEM004
7x1 SxM	ATEM005
8x1.25 DxM	ATEM006
8x1.25 SxF	ATEM007
8x1.25 SxM	ATEM008
8x1.25 SxM EFCO	ATEM017
10x1 SxF STIHL	ATEM009
10x1 SxF	ATEM010
10x1.25 SxF	ATEM011
10x1.25 SxM	ATEM012
10x1.5 SxF	ATEM013
10x1.5 SxM	ATEM014
12x1.5 SxF	ATEM015
12x1.75 SxF	ATEM016

Dx=right / Sx=left  
M=male / F=female



ATEM045

Aluminum eyelet sleeves replacement



ATEM048

Aluminum knob replacement



ATEM047

Spring replacement

Box Pcs 50

Pallet Pcs 1200





# Attilina

## Universal head multiline

Universal head, milled aluminum boss, suitable for 99% of machines on the market.  
It features an extreme ease of use.  
Produced with high resistance polyamide.



Made in Italy



ATFU002  
325gr

Box Pcs	25
Pallet Pcs	600

Made in Italy

# Queen

## Universal head multiline

Universal head, with poliammide ring and boss.  
Manufactured in high strength polymer.



ATFU001  
225gr



Box Pcs	25
Pallet Pcs	600



# Prince

## Universal head multiline

Universal professional head with milled aluminum body. Suitable for all machines in the the most severe conditions of use.

Available also with spinning cup, it features an amazing simplicity of use.

Ultra-fast line replacement.

Made in Italy



ATFU031  
Standard  
400gr



ATFU031-CR  
400gr

Box Pcs 25

Pallet Pcs 600

Multi-wire

# Mini-mulcher

## Universal head multiline

Universal, milled aluminum head, suitable for machines of any kind and displacement.

Made in  Italy



ATFU051  
Mini-mulcher 12 lines  
288gr



ATFU055  
Mini-mulcher 8 lines  
288gr

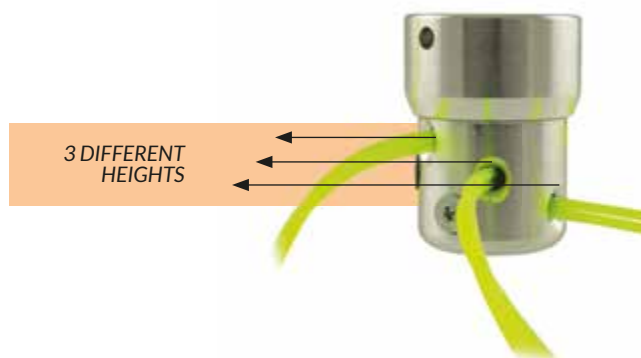

Box Pcs	30
Pallet Pcs	720

Multi-wire

# Attila

## Universal multiline mulching head

Universal head 6 wires mulching system.  
Recommended for machines from 30cc.  
Milled aluminum boss.  
Body made with high strength polyamide.

*Made in Italy*

ATFU005  
Attila  
317gr

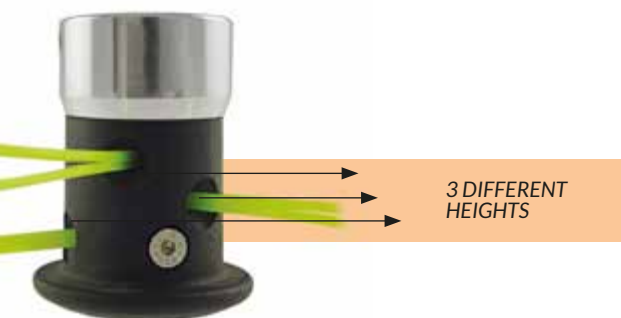

Box Pcs	50
Pallet Pcs	1200



# Trottola Maxi

## Universal head and multiline brush

Universal multifilament head with up to 6 wires on 3 different cutting heights.  
Built entirely in milled aluminum.  
Indestructible.  
Mulching effect.  
Recommended for machines 30 cc or more.

\* Brush accessory (optional) Brush disc with 16 wires.

Made in Italy



ATFU091  
Trottola Maxi  
360gr



\* ATFU096  
Optional brush tool for Trottola Maxi  
130gr

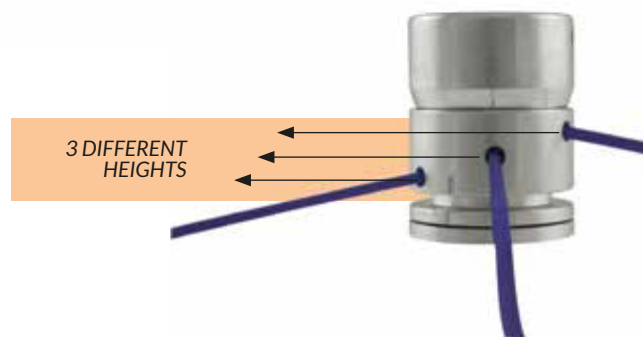

Box Pcs	30
Pallet Pcs	720

# Vittoria

## Universal hobby head

Hobby head light and robust with 4 wires.  
Made of high-strength polymers.  
Suitable for machines of any displacement.  
Toolless wire load, universal mount.  
2 different cutting heights.

Made in Italy



ATFU079  
100gr

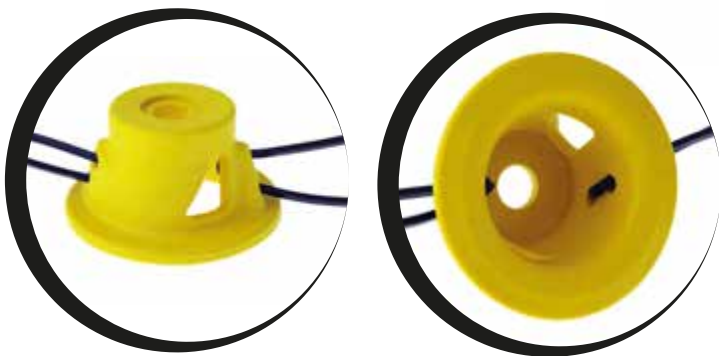

Box Pcs	50
Pallet Pcs	1200

Made in Italy

# Sgorbio

## Universal multiline mulching head

Universal head, hobby use.  
Made with milled aluminum, suitable for 99% of machines  
on the market.  
Toolless wire change.  
55mm diameter, strong and lightweight.

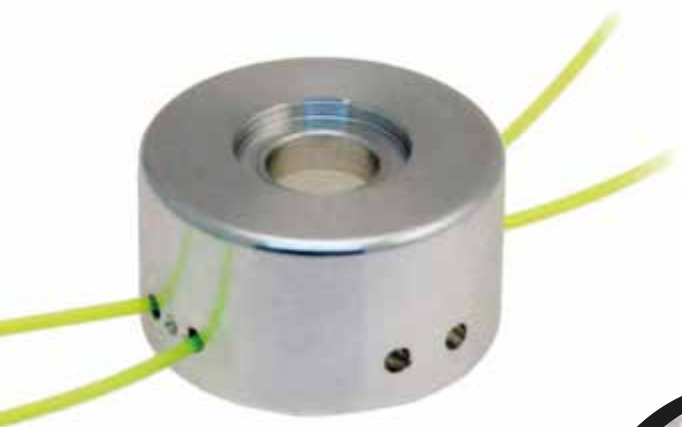

ATFU037  
100gr



Box Pcs	100
Pallet Pcs	2400

# Tango

## Universal multiline head

Brushcutter head with milled aluminum boss and body, sturdy and lightweight.

Universal attachment, multi line, low cutting height.

Fast wire replacement without dismantle the head.

Made in  Italy



ATFU100



Box Pcs	50
Pallet Pcs	1200



*Multi-wire*

# Baffo

## Universal multiline head

Brushcutter head entirely made with milled aluminum.  
Sturdy and lightweight.  
Universal attachment, multi line, low cutting height.  
Fast wire replacement without dismantle the head.

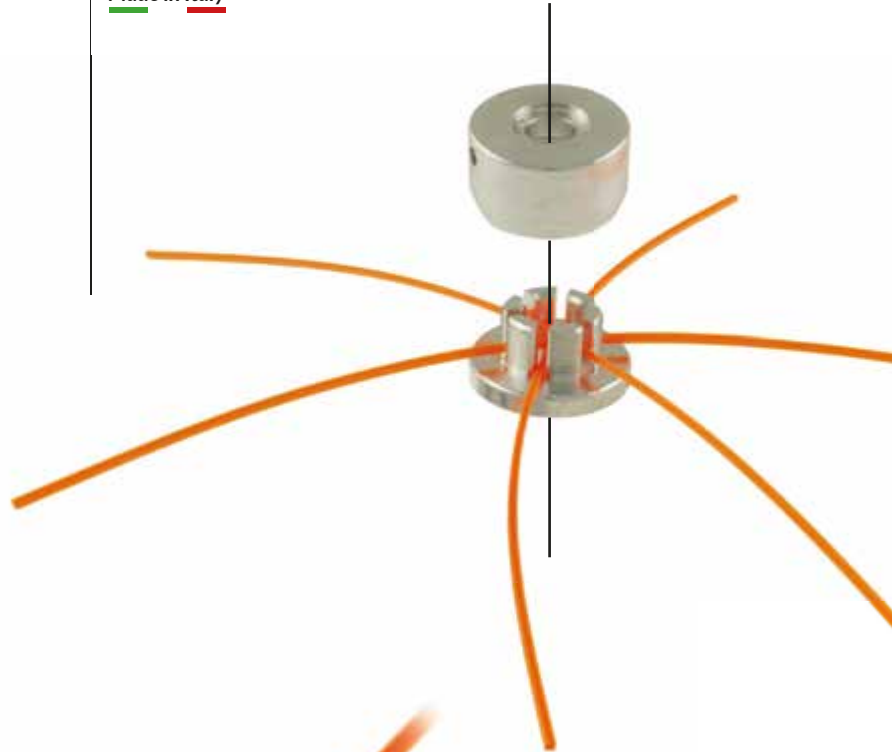
*Made in Italy*

ATBA001

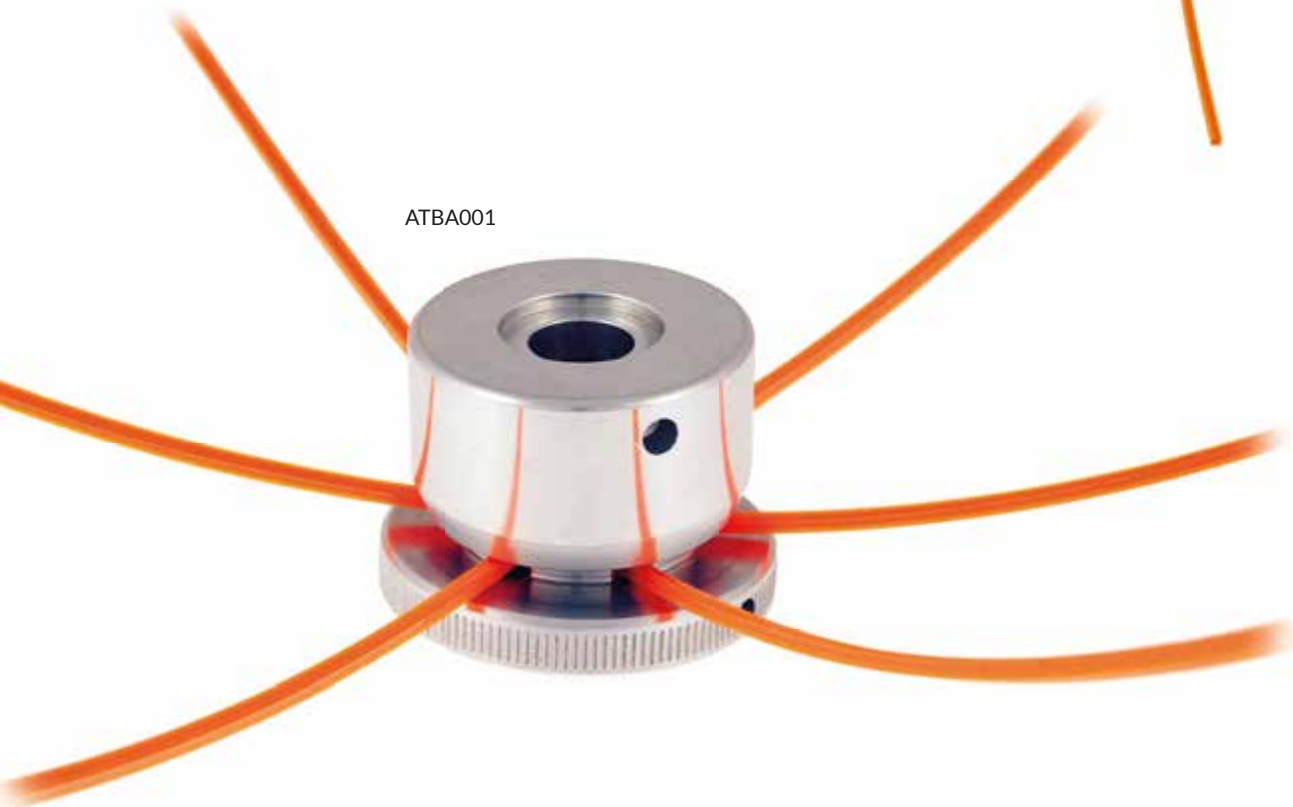

Box Pcs 50

Pallet Pcs 1200

Multi-wire

# Dominator 3 - 6

## Universal head technopolymer blade

Hard milled aluminum  
 Technopolymer blades with very high resistance to abrasion.  
 Multiple cutter extra performant.  
 The only model that complies with CE safety regulations.

Saw blade for bushes / brambles  
 Razor blade for grass

Engine 30-50cc

Made in Italy

Dominator 3 - ATDO006  
 3 RAZOR BLADES  
 476gr

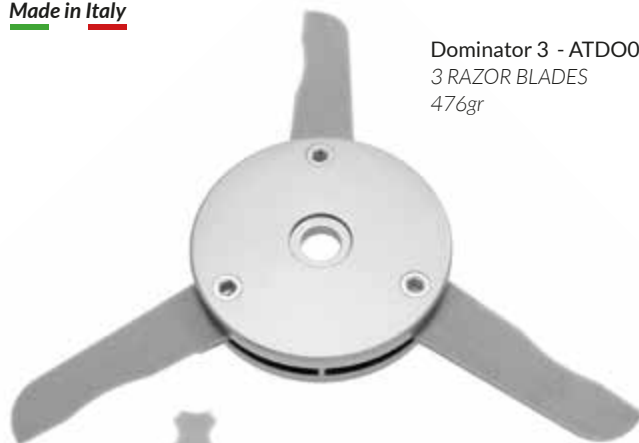

Dominator 3 - ATDO001  
 3 SAW BLADES  
 476gr



Dominator 6 - ATDO010  
 6 SAW BLADES  
 584gr



FIND OUT MORE



ATDO020	ATDO021
6x	6x
Razor blades	Saw blades
ATDO022	ATDO023
24x	24x
Razor blades	Saw blades

Box Pcs 10

# Ninja

## Anti-tangle disk

Ninja is a special attachment placed between the brush-cutter head and the gear case. Thanks to its design, it prevents the tangle of weeds during the work.

The Ninja-F40 version is specifically designed for our "mushroom" heads (Attilina, Queen, Prince, ...) and fits in the middle, under the ferrule.

Made in Italy

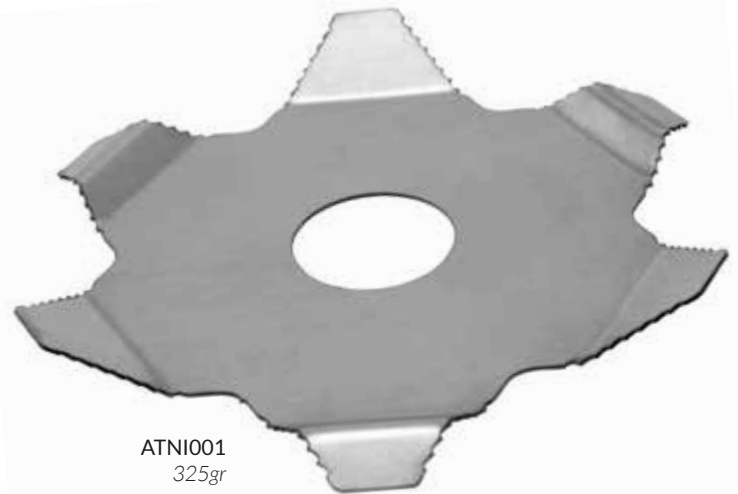

ATNI001  
325gr



code	description
ATNI001	Ninja UNIVERSAL disk
ATNI001-F20	Ninja disk adaptable to STIHL
ATNI002-F40	Ninja disk for AGP's mushroom heads

Box Pcs 75

Pallet Pcs 1800





***Top rated professional experience.***  
Components made in Italy since 1997.

# SPECIAL APPLICATIONS

## Rotary tiller

Mytilla 4	50
Mytilla 2	53
Top Keeper	54

## Suckers remover

Spollonatore 100	56
Spollonatore 150	57
Spollonatore 230	58
Spollonatore 230 light	59

## Brushes and accessories

Small Brush	62
Big Brush	63
Nyobrush	64
Turbo Brush	66
Turbo brush accessories	67





# Mytilla 4

## Universal rotary tiller

Universal rotary tiller suitable to any brushcutter with straight shaft, perfect for narrow places. Light-weight but very tough for hard job. It works in any place that engine tiller could never reach: hedges, vineyards, back gardens, salad plants. Milled aluminum body, gears and teeth made of high tenacity steel.

Guard, rods and shaft adapter are supplied.

Universal rotary tiller attachment. Keep out weeds from your garden!



Made in Italy

PATENTED



ATMY001  
Mytilla with 4 drills  
2200gr



ATMY002

Replacement teeth kit for Mytilla 4



ATMY003

Kit for upgrade the Mytilla 4 before 2017 to the version





FIND OUT MORE









# Mytilla 2

## Universal rotary tiller

Universal rotary tiller suitable to any brushcutter with straight shaft, perfect for narrow places. Light-weight but very tough. It works in any place that engine tiller could never reach: hedges, vineyards, back gardens, salad plants. Milled aluminum body, gears and teeth made of high tenacity steel.

Guard, rods and shaft adapter are supplied.

Universal rotary tiller attachment.  
Keep out weeds from your garden!

Made in Italy

PATENTED



ATMY010  
Mytilla with 2 drills  
1150gr



ATMY011

Replacement teeth for  
Mytilla 2



Rotary tiller

# Top Keeper

## Universal scarifier

Universal scarifier for brushcutter designed to thoroughly clean the substrate of synthetic lawns, but also runs perfectly on natural lawn!



Made in  Italy



ATTK001  
TOP KEEPER  
2200gr



ATTK002

Replacement springs for  
Top Keeper  
16 Left + 16 Right

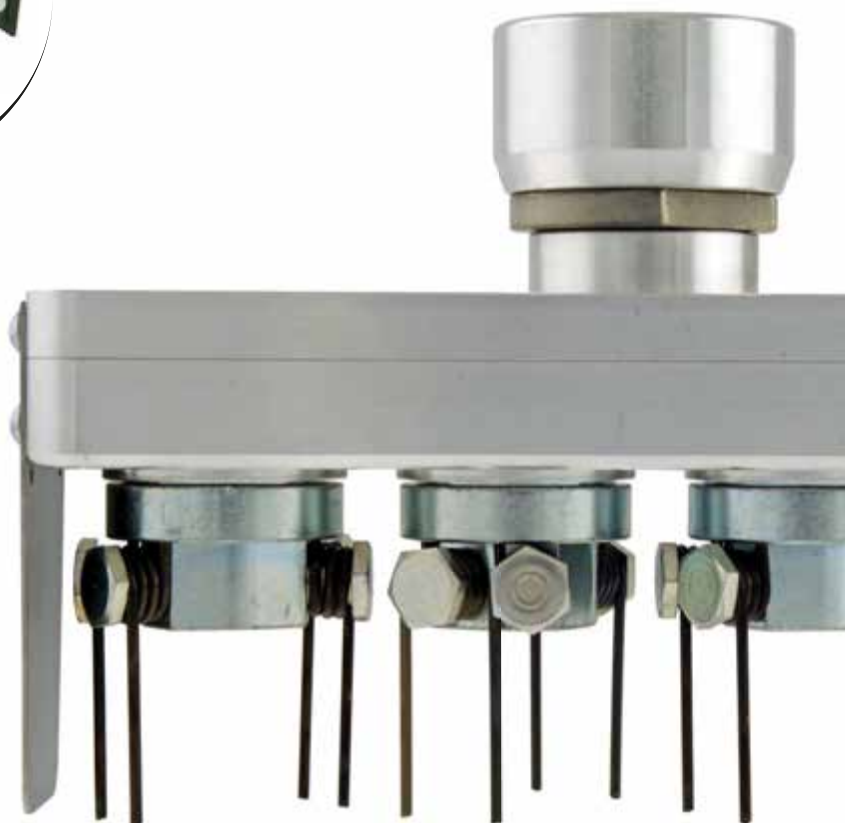

FIND OUT MORE



*Suckers remover*

# Spollonatore 100

## Universal attachment

Universal attachment for cutting suckers with tree bark protection.  
100 mm disc diameter.

Made in  Italy



ATSP001-100



ATDI014-100

Replacement disk

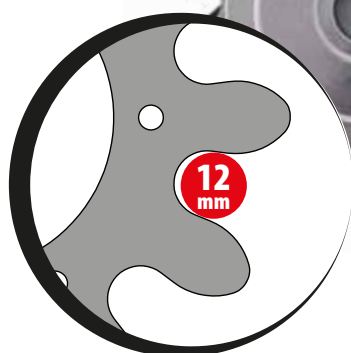

ATSP001-100  
650gr

FIND OUT MORE





*Suckers remover*

# Spollonatore 150

## Universal attachment

Universal attachment for cutting suckers with tree bark protection.  
150 mm disc diameter.

Made in  Italy



ATSP001-150

FIND OUT MORE



ATDI014-150

Replacement disk

ATSP001-150  
980gr

*Suckers remover*

# Spollonatore 230

## Universal attachment

Universal attachment for cutting suckers with tree bark protection.

With upper protection disk.

230 mm disc diameter.

Made in  Italy



ATSP001



ATDI014

Replacement disk

14  
mmATSP001  
1414gr

FIND OUT MORE



*Suckers remover*

# Spollonatore 230 light

## Universal attachment

Universal attachment for cutting suckers with tree bark protection.  
With lower protection disk.  
230 mm disc diameter.

Made in Italy



ATSPL01-230



ATSPL01-230  
1100gr



ATDI014

Replacement disk

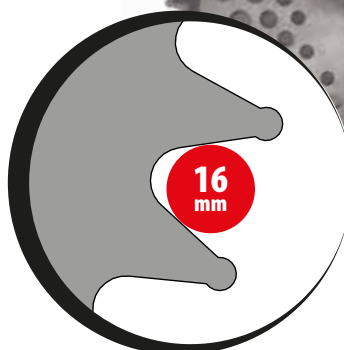











# Small Brush

## Universal brush 80 mm

Multi-wire universal brush, with up to 16 wires. Suitable for brushcutters with small displacement too. More delicate than brush with steel bristles, it ensures excellent cleaning of the cobblestones. Available in milled aluminum or high resistance polymers.

Made in  Italy



ATSPA31  
Aluminum brush Ø 80 mm  
270gr

ATSPA40-45  
PA brush Ø 80 mm  
80gr



Box Pcs	25
Pallet Pcs	600



# Big Brush

## Universal brush 120 mm

Multi-wire universal brush, with up to 36 wires. Suitable for all brushcutters and recommended >30cc.

More delicate than brush with steel bristles, it ensures excellent cleaning of the cobblestones.

Available in milled aluminum or high resistance polymers.

Made in  Italy



ATSPA34  
Aluminum Brush Ø 120 mm  
500gr

ATSPA50-45  
PA brush Ø 120 mm for lines up to 3.0 mm  
250gr

ATSPA50-65  
PA brush Ø 120 mm for lines from 3.3 mm  
250gr



FIND OUT MORE



Box Pcs 20

Pallet Pcs 480

# Nyobrush

## Universal brush made in technopolymer

The most delicate.

Particularly suitable for cleaning and weeding delicate surfaces that can not be treated with steel brushes.

Very light and resistant, they remove moss and grass on all surfaces. They clean sidewalks, setts, swimming pools, car parks, etc.

20 and 25.4 mm universal mounting diameter.

Recommended for all 30cc brushcutters and above.

Made in  Italy

ATSPA55  
Nyobrush Ø 140 mm  
470gr

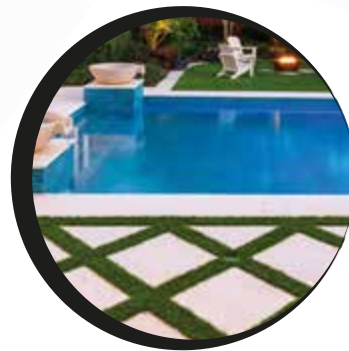







# Turbo Brush

## Steel and Aluminum Brush

Universal metal brush with steel bristles.  
Fits all brush cutters.  
Indicated for cleaning cobblestones.  
STIHL adapter included.



Before



After



ATSPA01-170  
Ø 170 mm  
750gr

Box Pcs	8
Pallet Pcs	320

Made in  Italy



ATSPA01-200  
Ø 200 mm  
1200gr

Box Pcs	6
Pallet Pcs	240



Mounting

Gearcase NOT supplied

FIND OUT MORE



# Turbo Brush Accessories

## Guard and Cover for metal brush

Made in Italy

Guard for Universal Brush suitable for all brushcutters. The protection move from work to rest position without disassembling.

Cover (auxiliary accessory) used with guard, provides greater security to the people and objects that will be around you.



**ATSPA10**  
Guard for Steel brush  
780gr



**ATSPA26**  
OPTIONAL  
Cover for Steel brush  
UNIVERSAL  
400gr



Steel brush NOT supplied



**ATSPA30**  
Brush guard and  
cover together  
1180gr







***Top rated professional experience.***  
Components made in Italy since 1997.



# BLADES

Elastoblade 70

## **Steel blades**

Made in Italy 72

2 teeth discs 73

Various Blades 74

Widia Blades 74

Made in Japan 75



# Elastoblade

Made in Italy

Brushcutter blade made with high resilience thermoplastic elastomer: flexible, robust and wear resistant. Suitable for edging walls and sidewalks, it also works great on the joints of cobblestones. Ultra sharp serrated edge.

Made in  Italy

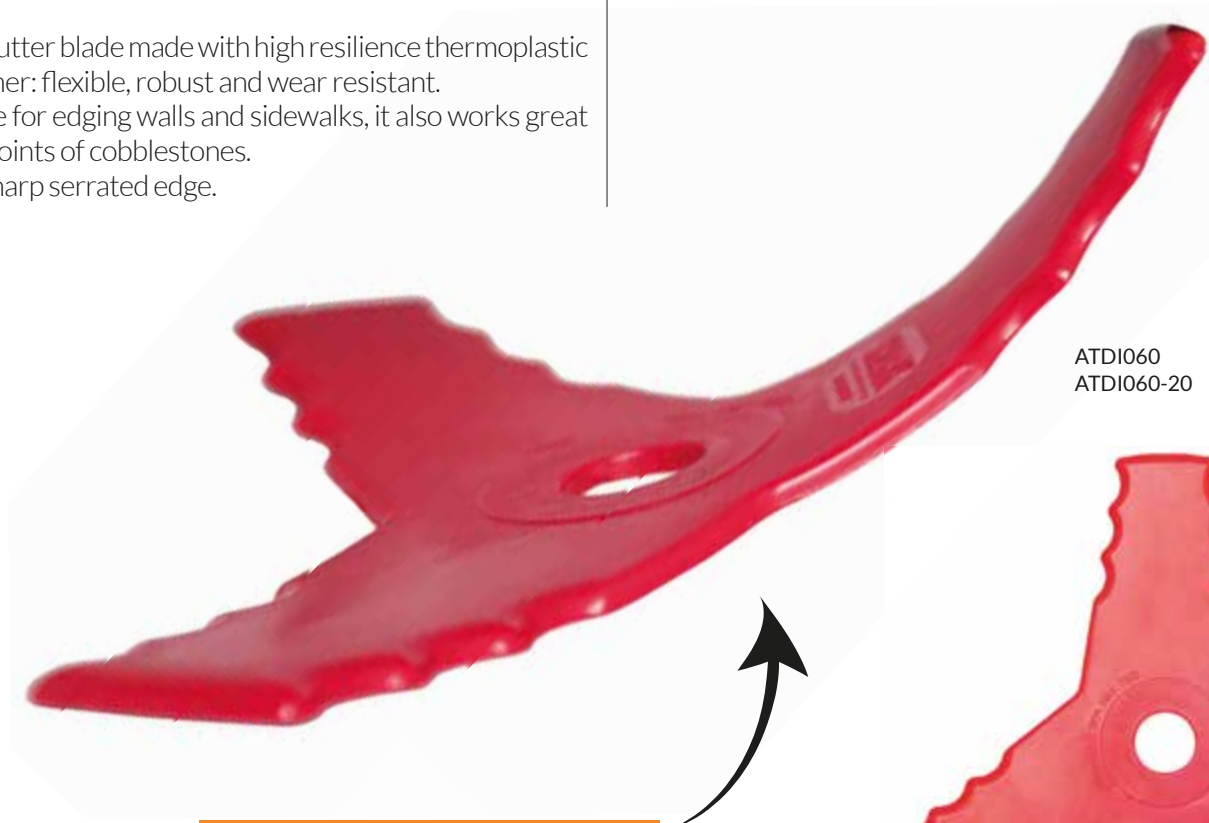

ATDI060  
ATDI060-20

**SUPER FLEXIBLE & UNBREAKABLE**



ATDI060	Ø 250 x 25.4 - 4.0 mm
ATDI060-20	Ø 250 x 20.0 - 4.0 mm

**FIND OUT MORE**



Box Pcs 25







# Made in Italy

## Steel blades

Super professional steel discs.  
High cutting performance, the special serration profile doesn't require sharpening.  
Wear resistant and corrosion protection thanks to the electrophoretic deposition.

Complies with UNI ISO 7113

Made in  Italy



Serrated blade for shrubs.

		Box Pcs
ATDI047	Ø 250 x 25.4 - 3.0 mm	50
ATDI048	Ø 300 x 25.4 - 3.0 mm	



Serrated blade for shrubs.

		Box Pcs
ATDI049	Ø 305 x 25.4 - 3.0 mm	25



Mulching steel blade. Suggested for machines > 35 cc.

			Box Pcs
ATDI015	FORZA 8	Ø 250 x 25.4 - 3.0 mm	20
ATDI016	FORZA 8	Ø 250 x 20.0 - 3.0 mm	



Mulching steel serrated blade for brambles. Excellent cutting capacity, wear resistant. Suggested for machines > 35 cc.

			Box Pcs
ATDI042	FORZA 8 ROVI	Ø 250 x 25.4 - 3.0 mm	20



Mulching steel blade, lightened and serrated. Excellent cutting capacity. Suggested for machines > 30 cc.

			Box Pcs
ATDI046	FORZA 8 S PRO	Ø 250 x 25.4 - 3.0 mm	20

## 2 teeth discs



Blade for cut grass and brushwood.  
2 teeth

		Box Pcs
ATDI024	Ø 250 x 25.4 - 3.0 mm	50
ATDI025	Ø 300 x 25.4 - 3.0 mm	



Blade for cut grass and brushwood.  
2 teeth - 90 mm width

		Box Pcs
ATDI021	Ø 255 x 25.4 - 1.4 mm	50
ATDI022	Ø 255 x 25.4 - 1.6 mm	
ATDI022-20	Ø 255 x 20 - 1.6 mm	
ATDI023	Ø 305 x 25.4 - 1.8 mm	25
ATDI043	Ø 305 x 25.4 - 2.0 mm	



Saw blade. 2 teeth - 90 mm width

		Box Pcs
ATDI031	Ø 305 x 25.4 - 1.6 mm	50



Blade for brambles. 2 teeth

		Box Pcs
ATDI026	Ø 310 x 25.4 - 3.0 mm	30



Blade for brambles. 2 teeth

		Box Pcs
ATDI033	Ø 300 x 25.4 - 3.0 mm	20
ATDI034	Ø 320 x 25.4 - 4.0 mm	



Saw blade for brambles. 2 teeth

- Doesn't require sharpening
- CUTS and RIPS

		Box Pcs
ATDI030	Ø 305 x 25.4 - 3.0 mm	25

FIND OUT MORE



## Various blades



Blade for cut grass, brushwood and bushes. 3 teeth

		Box Pcs
ATDI028	Ø 250 x 25.4 - 3.0 mm	30
ATDI029	Ø 300 x 25.4 - 3.0 mm	25



Blade for cut grass, brushwood and bushes. 3 teeth

		Box Pcs
ATDI037	Ø 255 x 25.4 - 1.4 mm	40



Blade for cut grass, brushwood and bushes. 4 Teeth

		Box Pcs
ATDI038	Ø 255 x 25.4 - 1.4 mm	40



Blade for cut grass, brushwood and bushes. 8 teeth

		Box Pcs
ATDI039	Ø 255 x 25.4 - 1.4 mm	40



Blade for shrubbery. 80 teeth

		Box Pcs
ATDI040	Ø 255 x 25.4 - 1.4 mm	40

## Widia blades



Disc for small logs. 40 teeth

			Box Pcs
ATDI014	WIDIA	Ø230x254-2.0mm	25
ATDI036	TCT	Ø255x254-2.0mm	50

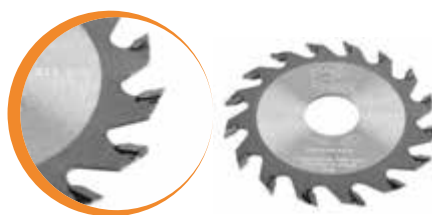

Saw blade. 16 teeth

		B.Pcs	
ATDI014-100	WIDIA	Ø100x254-2.0mm	25



Saw blade. 26 teeth

		B.Pcs	
ATDI014-150	WIDIA	Ø150x254-2.0mm	25



# Made in Japan

## Widia blades

Widia blade for brush cutter with holes. With tungsten carbide tips 255 mm x 40 teeth.

For hard undergrowth and brambles

Made in Japan



		Box Pcs
ATDI019	Ø 255 x 25.4 - 2.0 mm	25





***Top rated professional experience.***  
Components made in Italy since 1997.

# PPE

## For the brushcutter

Face shields	78
Brushcutter guard	80
Shoulder straps	81





For the brushcutter

# Face shields

## Mesh and polycarbonate face shields

They can be used in all situations where face protection is required.

Double adjustment headboard. The screen can rotate 90°.

100% Made in Italy by AGP.



Approved according to the new regulations EN ISO 16321  
Compliant with regulation EU 2016/425 Attachment II



ATVI060  
Wire mesh

Box Pcs	30
Pallet Pcs	720



ATVI061-AR  
Wire mesh

Box Pcs	10
Pallet Pcs	240



ATVI042-AR  
Wire mesh



Box Pcs	10
Pallet Pcs	240



For the brushcutter



ATVI050  
Polycarbonat



ATVI051-AR  
Polycarbonat

Box Pcs	40
Pallet Pcs	960



Box Pcs	15
Pallet Pcs	360



ATVI032-AR  
Polycarbonat



Box Pcs	15
Pallet Pcs	360

## Deflectors

Produced in high resistance polymer,  
with wire cutter blade.  
Rubber reductions kit for  
24, 26, 28 mm shaft.



**ATR078**  
UNIVERSAL deflector, super professional

Box Pcs 15

Produced in high resistance polymer.  
Rubber reductions kit for  
24, 26, 28, 30, 32 mm shaft.



**ATR070**  
UNIVERSAL deflector, super professional

Box Pcs 15

Produced in toughened polymer.  
Rubber reductions kit for  
24, 26, 28, 30, 32 mm shaft.



**ATR080**  
UNIVERSAL deflector, standard version

Box Pcs 25



*For the brushcutter*

## Shoulder straps

Standard diagonal shoulder strap.



ATBR001

Box Pcs

50

Semipro shoulder strap with side protection.



ATBR002

Box Pcs

25

Professional shoulder strap with double harness.



ATBR003

Box Pcs

25

Shoulder strap with side protection and quick release.



ATBR004

Box Pcs

10



*Top rated professional experience.*  
Components made in Italy since 1997.

# SPARE PARTS AND ADAPTERS

Heads spare parts	84
Accessories and Spare Parts / Adapters / Nuts / Screws for brushcutters	86
Eyelet sleeves	90





# Heads spare parts

FRANZ / FRANZEVO / KING

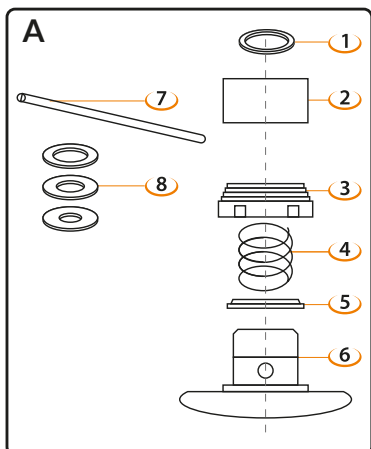

ATTILINA / ATTILINA EVO / QUEEN

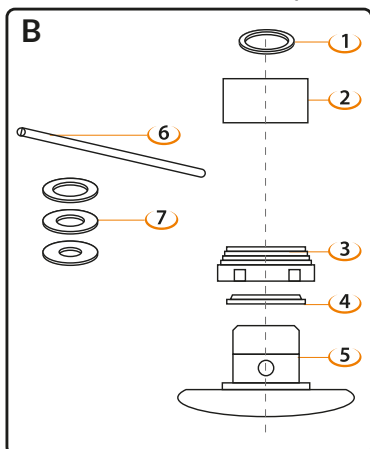

ATTILA / POWER MULCHER

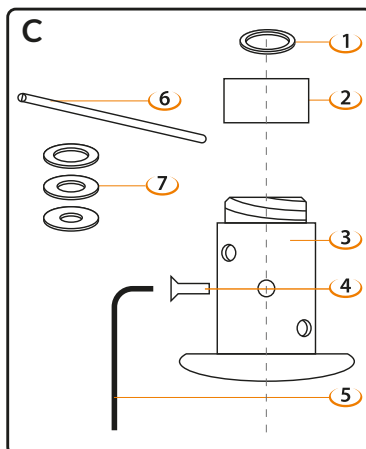

BATTI E VAI UNIVERSALE

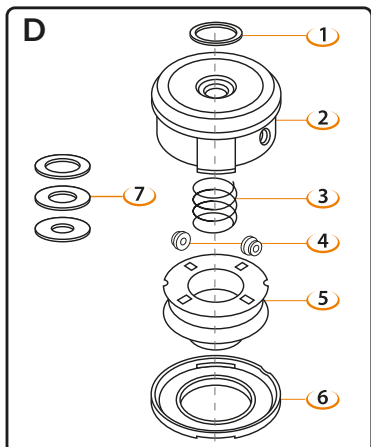

BATTI E VAI FILETTATA

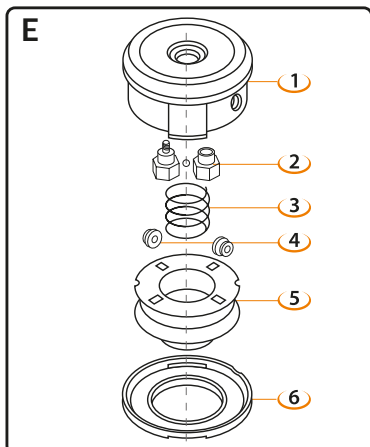

SMART BUMP&GO

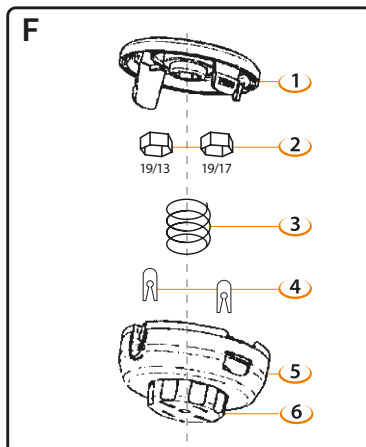

GARDEN DEVIL UNIVERSALE

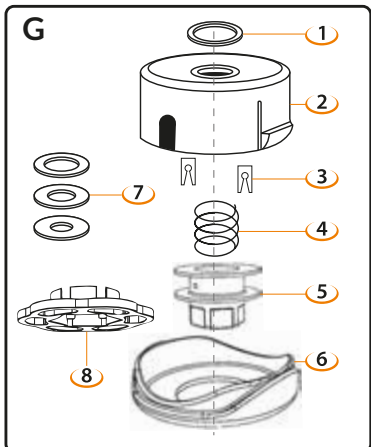

GARDEN DEVIL FILETTATA

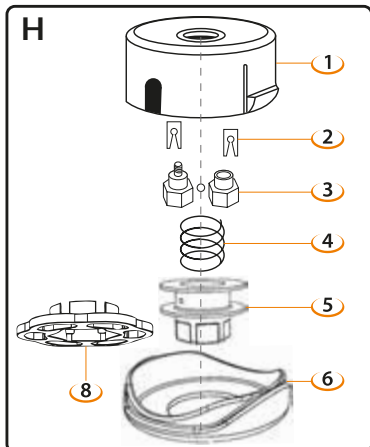

EMILY

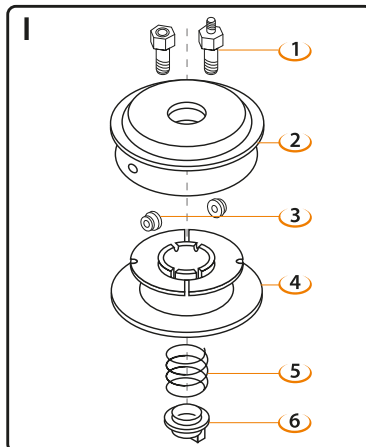

A

FRANZ		
#1	ATFU006	centraggio (1":20 mm)
#2	ATFU013	ghiera in alluminio
#3	ATFU015	ghiera fermafilo
#4	ATFU016	molla
#5	ATFU017	rondella fermafilo
#6	ATFU018	corpo testina
#7	ATFU011	astina
#8	ATFU012	kit rondelle

FRANZ EVOLUTION		
#1	ATFU006	centraggio (1":20 mm)
#2	ATFU013	ghiera in alluminio
#3	ATFU040	ghiera line cooling system
#4	ATFU016	molla
#5	ATFU017	rondella fermafilo
#6	ATFU041	corpo testina
#7	ATFU011	astina
#8	ATFU012	kit rondelle

KING		
#1	ATFU006	centraggio (1":20 mm)
#2	ATFU013	ghiera in alluminio
#3	ATFU015	ghiera fermafilo
#4	ATFU016	molla
#5	ATFU017	rondella fermafilo
#6	ATFU019	corpo testina
#7	ATFU011	astina
#8	ATFU012	kit rondelle

B

ATTILINA		
#1	ATFU006	centraggio (1":20 mm)
#2	ATFU013	ghiera in alluminio
#3	ATFU008	ghiera fermafilo
#4	ATFU009	rondella fermafilo
#5	ATFU014	corpo testina
#6	ATFU011	astina
#7	ATFU012	kit rondelle

ATTILINA EVOLUTION		
#1	ATFU006	centraggio (1":20 mm)
#2	ATFU013	ghiera in alluminio
#3	ATFU046	ghiera line cooling system
#4	ATFU009	rondella fermafilo
#5	ATFU014	corpo testina
#6	ATFU011	astina
#7	ATFU012	kit rondelle

QUEEN		
#1	ATFU006	centraggio (1":20 mm)
#2	ATFU007	ghiera in p.a.
#2	ATFU025	ghiera in p.a. filetto dx
#3	ATFU008	ghiera fermafilo
#4	ATFU009	rondella fermafilo
#5	ATFU010	corpo testina
#5	ATFU026	corpo testina filetto dx
#6	ATFU011	astina
#7	ATFU012	kit rondelle

C

ATTILA		
#1	ATFU006	centraggio (1":20 mm)
#2	ATFU013	ghiera in alluminio
#3	ATFU020	corpo testina
#4	ATFU021	vite fermafilo
#5	ATFU022	chiave a brugola
#6	ATFU011	astina
#7	ATFU012	kit rondelle

D

UNIVERSAL TAP&GO		
#1	ATFU006	centraggio (1":20 mm)
#2	ATBV070	corpo superiore
#3	ATBV043	molla conica
#4	ATBV045	passafilto
#5	ATBV044	rocchetto avvolgifiio
#6	ATBV046	corpo inferiore
#7	ATFU012	kit rondelle

E

TAP&GO FILETTATA		
#1	ATBV030	corpo superiore
#2 perno testina	ATBV032	8x1.25 sx femmina
	ATBV033	8x1.25 sx maschio
	ATBV034	8x1.25 sx maschio (efco)
	ATBV035	10x1 sx femmina (stihl)
	ATBV036	10x1 sx femmina
	ATBV037	10x1.25 sx femmina
	ATBV038	10x1.25 sx maschio
	ATBV039	10x1.5 sx femmina
	ATBV040	10x1.5 sx maschio
	ATBV041	12x1.5 sx femmina
	ATBV042	12x1.75 sx femmina
	#3	ATBV043
#4	ATBV045	passafilto
#5	ATBV044	rocchetto avvolgifiio
#6	ATBV046	corpo inferiore

F

SMART BUMP & GO		
#1	ATBVC63	corpo superiore
#2	ATBVC68	kit adattatore esagono
#3	ATBVC65	molla
#4	ATBVC67	passafilto
#5	ATBVC62	corpo inferiore
#6	ATBVC64	rocchetto avvolgifiio
#6	ATBVC66	rocchetto avv. alu

G

UNIVERSAL GARDEN DEVIL		
#1	ATFU006	centraggio (1":20 mm)
#2	ATBVA01	corpo superiore
#3	ATBVA03	passafilto
#4	ATBVA04	molla
#5	ATBVA05	rocchetto
#5	ATBVA06	rocchetto rinforzato
#6	ATBVA07	corpo inferiore
#7	ATFU012	kit rondelle
#8	ATBVA09	magic key

H

GARDEN DEVIL FILETTATA		
#1	ATBVA02	corpo superiore
#2	ATBVA03	passafilto
#3 perno testina	ATBV032	8x1.25 sx femmina
	ATBV033	8x1.25 sx maschio
	ATBV034	8x1.25 sx maschio (efco)
	ATBV035	10x1 sx femmina (stihl)
	ATBV036	10x1 sx femmina
	ATBV037	10x1.25 sx femmina
	ATBV038	10x1.25 sx maschio
	ATBV039	10x1.5 sx femmina
	ATBV040	10x1.5 sx maschio
	ATBV041	12x1.5 sx femmina
ATBV042	12x1.75 sx femmina	
#4	ATBVA04	molla
#5	ATBVA05	rocchetto
#5	ATBVA06	rocchetto rinforzato
#6	ATBVA07	corpo inferiore
#8	ATBVA09	magic key

I

EMILY		
#1 perno testina	ATEM030	6x1 dx maschio
	ATEM031	6x1 sx maschio
	ATEM032	7x1 sx maschio
	ATEM033	8x1.25 dx femmina
	ATEM034	8x1.25 sx femmina
	ATEM035	8x1.25 sx maschio
	ATEM050	8x1.25 sx maschio (efco)
	ATEM036	10x1 sx femmina (stihl)
	ATEM037	10x1 sx femmina
	ATEM038	10x1.25 sx femmina
	ATEM039	10x1.25 sx maschio
	ATEM040	10x1.5 sx femmina
	ATEM041	10x1.5 sx maschio
ATEM042	12x1.5 sx femmina	
ATEM043	12x1.75 sx femmina	
#2	ATEM044	corpo superiore
#3	ATEM045	passafilto
#4	ATEM046	corpo inferiore
#5	ATEM047	molla
#6	ATEM048	pomelli in alluminio
#6	ATEM049	pomelli in alluminio fil. dx

# Accessories and Spare Parts / Adapters / Nuts / Screws for brushcutters



Replacement spring for brushcutter heads	
ATBV043	Spring for "Tap and Go" Attila
ATFU016	Spring for King and Franz
ATEM047	Master - Veracut - Emily (TECOMEC 5040021)
ATMO002	Farmer - Trimmer (aluminum knob - TECOMEC 5030010)
ATMO004	"Tap and Go" - Sabart - Tecomec etc ... (TECOMEC 5070004)
ATMO003	Arnetoli F202-KZ2F-M400-F102-F104 P120-S120PA-P130PA

Box Pcs 100



Box with Left accessories for brush cutter	
ATRT090	Left adapters box (60 pcs)
ATRT092	Left bolts + left nuts box (110 pcs)
ATRT091	Left bolts box (60 pcs)
ATRT093	Left nuts box (60 pcs)



Head knob Emily - Veracut	
ATEM048	Left threaded (Standard) (TECOMEC 5040022)
ATEM049	Right thread for trimmer without bevel gear (TECOMEC 5040023)

Box Pcs 100



Metal fixed cup	
ATRG001	A = Ø 8 mm
ATRG002	A = Ø 10 mm
ATRG005	A = Ø 12 mm

Box Pcs 100







# Heads spare parts



Adapters for brushcutters heads	
ATRT030	M8x1.25 Sx-Left / M7x1.00 Sx-Left
ATRT031	M8x1.25 Sx-Left / M8x1.25 Sx-Left
ATRT032	M10x1.25 Sx-Left / M7x1.00 Sx-Left
ATRT033	M10x1.25 Sx-Left / M8x1.25 Sx-Left
ATRT034	M10x1.25 Sx-Left / M10x1.25 Sx-Left
ATRT035	M10x1.25 Sx-Left / M10x1.50 Sx-Left

Box Pcs 100



Nut with left thread	
ATRG045	M8x1.25 Sx-Left
ATRG046	M10x1.00 Sx-Left
ATRG047	M10x1.25 Sx-Left
ATRG048	M10x1.50 Sx-Left
ATRG049	M12x1.50 Sx-Left
ATRG050	M12x1.75 Sx-Left

Box Pcs 100



Screw with left thread	
ATRG060	M7x1.00 Sx-Left - L. 16 mm
ATRG061	M8x1.25 Sx-Left - L. 20 mm
ATRG062	M10x1.25 Sx-Left - L. 20 mm
ATRG063	M10x1.50 Sx-Left - L. 20 mm

Box Pcs 100



Adapter set	
ATFU006-ME	Metal centering ring 1" → 20 mm

Box Pcs 100

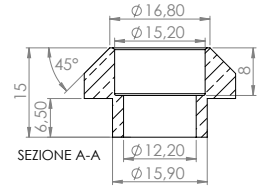

Adapter set	
ATRG004	Adapter Husqvarna - Jonsered - Partner

Box Pcs 100

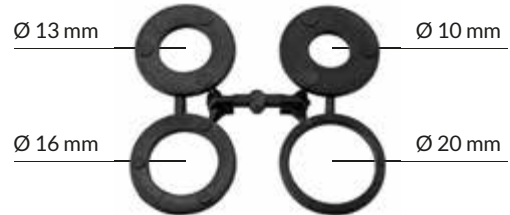

Adapter set	
ATFU012	Polyamide washer adapters set (25.4 mm)

Box Pcs 100

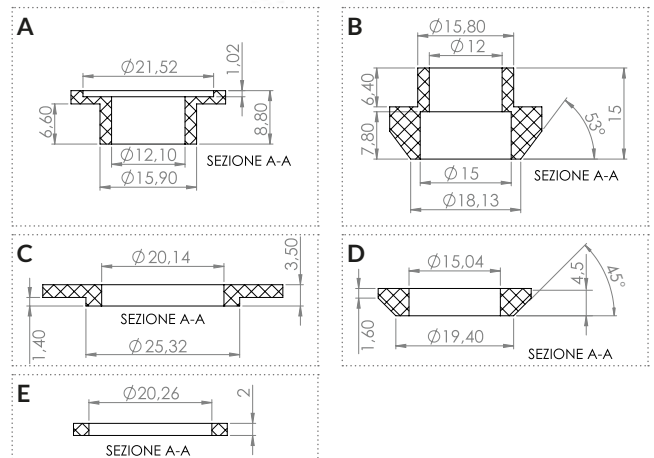
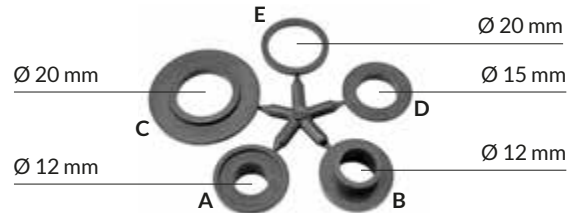

Adapter set	
ATFU039	Polyamide washer adapters set

Box Pcs 100





# Eyelet sleeves

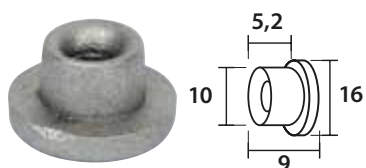

ATEM045 Emily

Box Pcs 200

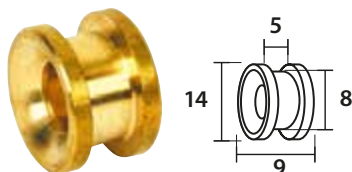

ART007 Bluebird

Box Pcs 200

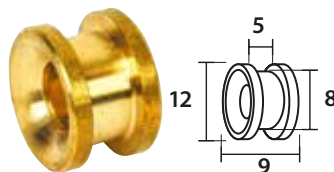

ART001

Box Pcs 200

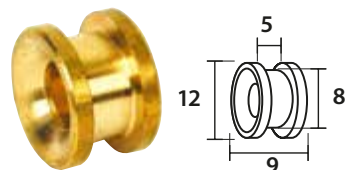

ART008 Active

Box Pcs 200

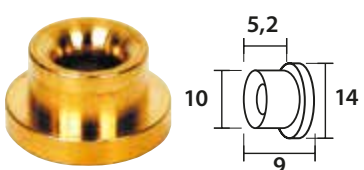

ART005 Tap & Go (sabart)

Box Pcs 200



ART002 F202-k2-m200-400Ametoli

Box Pcs 200

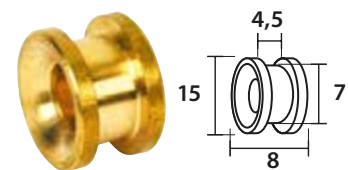

ART009 Forestal

Box Pcs 200

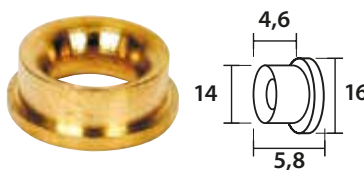

ATBV045 Tap & Go

Box Pcs 200

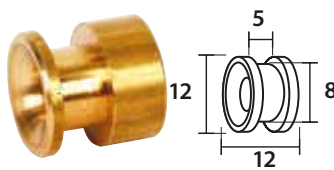

ART003 xx

Box Pcs 200

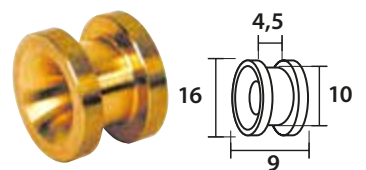

ART010 Active

Box Pcs 200

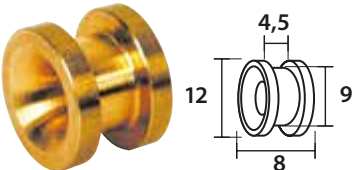

ART006 Farmer 1° tipo

Box Pcs 200



ATBVA03 Garden devil

Box Pcs 200





**AGP** s.r.l. Regione Taverne 72, Villafranca d'Asti (AT) 14018  
Tel. +39 0141 941113 | [attilagp@attilagp.it](mailto:attilagp@attilagp.it) | [www.attilagp.it](http://www.attilagp.it)